

# SIRUBA®

銀箭牌工業用縫紉機  
INDUSTRIAL SEWING MACHINE







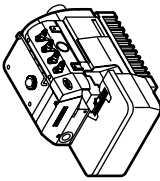
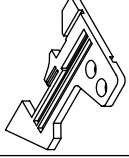

# 700F

## 零件圖 PARTS LIST

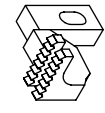

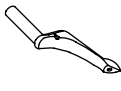

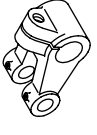



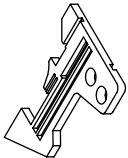
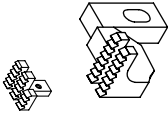
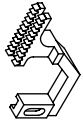

CE

 高林股份有限公司  
KAULIN MFG. CO., LTD.

 機 型 MODEL	 針板 NEEDLE PLATE	 送 具 FEED DOG	 送 具 FEED DOG	 押 具 PRESSER FOOT	 勾 針 LOOPER	 針 留 NEEDLE CLAMP	 束 子 COLLAR	 衝 程 CRANK	 衝 程 CRANK	 針 號 NEEDLE
737F-504M1-15	E934D	D438	D912	P152D-2	LP26	KG131-E	KJ10F	KF25-A	KJ09B-E	DC27 #9
737F-504M2-04	E800	D440	D095	P253E-3	LP26	KG131-E	KJ10F	KF25-A	KJ09B-E	DC27 #11
737F-504M2-04CT	E800C	D440	D095	P253E-3	LP26	KG131-E	KJ10F	KF25-A	KJ09B-E	DC27 #11
737F-504M2-04LFC-2	E800	D440	D095	P101-3	LP26	KG131-E	KJ10F	KF25-A	KJ09B-E	DC27 #11
737F-504M2-04LFC-2/EC	E800C	D440	D095	P101-3	LP26	KG131-E	KJ10F	KF25-A	KJ09B-E	DC27 #11
737F-504M2-04TR	E011	D015	D011	P101-3	LP26	KG131-E	KJ10F	KF25-A	KJ09B-E	DC27 #11
737F-504M2-04VT	E800	D440	D095	P253E-3	LP26	KG131-E	KJ10F	KF25-A	KJ09B-E	DC27 #11
737F-504M2-04WR/LF-B	E001				LP26	KG131-E	KJ10F	KF25-A	KJ09B-E	DC27 #11
737F-504M3-05PZ	E797	D440	D674	PZ01-A	LP26	KG131-E	KJ10F	KF25-A	KJ09B-E	DC27 #18
737F-504M3-05	E797	D440	D674	P230-3	LP26	KG131-E	KJ10F	KF25-A	KJ09B-E	DC27 #11
737F-504M3-05CT	E797C	D440	D674	P230-3	LP26	KG131-E	KJ10F	KF25-A	KJ09B-E	DC27 #11
737F-504M3-05VT	E797	D440	D674	P230-3	LP26	KG131-E	KJ10F	KF25-A	KJ09B-E	DC27 #11
737F-504M5-04BK	E589F	D969	D675	P975-3	LP26	KG131-E	KJ10F	KF25-A	KJ09B-E	DC27 #11
737F-504M5-04BK/VT	E589F	D969	D675	P975-3	LP26	KG131-E	KJ10F	KF25-A	KJ09B-E	DC27 #11
737F-505F1-04	E784	D438	D674	P152D-3	LP26	KG131-E	KJ10F	KF25-A	KJ09B-E	DC27 #9
737F-505F1-04ES	E784	D438	D674	P152D-3	LP26	KG131-E	KJ10F	KF25-A	KJ09B-E	DC27 #9
737F-505F1-04VT	E784	D438	D674	P152D-3	LP26	KG131-E	KJ10F	KF25-A	KJ09B-E	DC27 #9
737F-504M3-04	E796	D440	D674	P230-3	LP26	KG131-E	KJ10F	KF25-A	KJ09B-E	DC27 #11
737F-505F1-04ES/VT	E784	D438	D674	P152D-3	LP26	KG131-E	KJ10F	KF25-A	KJ09B-E	DC27 #9
737F-504M2-04EC	E800C	D440	D095	P253E-3	LP26	KG131-E	KJ10F	KF25-A	KJ09B-E	DC27 #11
737F-504M1-15VT	E934D	D438	D912	P152D-5	LP26	KG131-E	KJ10F	KF25-A	KJ09B-E	DC27 #9
737F-504M2-04TR/EC	E011C	D011	D015	P101-3	LP26	KG131-E	KJ10F	KF25-A	KJ09B-E	DC27 #11
737F-504F1-04	E784	D438	D674	P152D-3	LP26	KG131-E	KJ10F	KF25-A	KJ09B-E	DC27 #9

## 規格件表 CONVERSION CHART







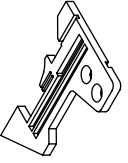
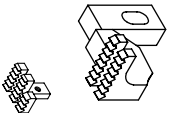
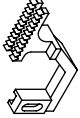

# 型別件對照表 MODEL COMPARE LIST

機 型 MODEL										
	針板 NEEDLE PLATE	送具 FEED DOG	送具 FEED DOG	押具 PRESSER FOOT	勾 針 LOOPER	針留 NEEDLE CLAMP	束 子 COLLAR	衝 程 CRANK	衝 程 CRANK	針 號 NEEDLE
737F-504F1-15	E471	D471	D472	LP26	KG131-E	KG131-E	KJ10F	KF25-A	KJ09B-E	DC27 #9
747F-512M1-25	E920	D440	D095	P253E-4	LP36	KG142-E	KJ13F	KF26-A	KJ11B-E	DC27 #11*2
747F-512M1-25CT	E920C	D440	D095	P253E-4	LP36	KG142-E	KJ13F	KF26-A	KJ11B-E	DC27 #11*2
747F-514H4-24GA	E919	D958	D095	P136-A	LP26	KG142-E	KJ13F	KF26-A	KJ11B-E	DC27 #11*2
747F-514H4-24GA/CT	E919C	D958	D095	P136-A	LP26	KG142-E	KJ13F	KF26-A	KJ11B-E	DC27 #11*2
747F-514H4-24GA/EC	E919C	D958	D095	P136-A	LP26	KG142-E	KJ13F	KF26-A	KJ11B-E	DC27 #11*2
747F-514H4-24GA/P	E919	D958	D095	P136P-A	LP26	KG142-E	KJ13F	KF26-A	KJ11B-E	DC27 #11*2
747F-514M2-24	E919	D440	D095	P253E-4	LP26	KG142-E	KJ13F	KF26-A	KJ11B-E	DC27 #11*2
747F-514M2-24CT	E919C	D440	D095	P253E-4	LP26	KG142-E	KJ13F	KF26-A	KJ11B-E	DC27 #11*2
747F-514M2-24EC	E919C	D440	D095	P253E-4	LP26	KG142-E	KJ13F	KF26-A	KJ11B-E	DC27 #11*2
747F-514M2-24LF-B	E919	D440	D095	P101-4	LP26	KG142-E	KJ13F	KF26-A	KJ11B-E	DC27 #11*2
747F-514M2-24LFC-2	E919	D440	D095	P101-4	LP26	KG142-E	KJ13F	KF26-A	KJ11B-E	DC27 #11*2
747F-514M2-24LFC-2/EC	E919C	D440	D095	P101-4	LP26	KG142-E	KJ13F	KF26-A	KJ11B-E	DC27 #11*2
747F-514M2-24TG	E919	D440	D095	P254G-4	LP26	KG142-E	KJ13F	KF26-A	KJ11B-E	DC27 #11*2
747F-514M2-24TG/EC	E919C	D440	D095	P254G-4	LP26	KG142-E	KJ13F	KF26-A	KJ11B-E	DC27 #11*2
747F-514M2-24VT	E919	D440	D095	P253E-4	LP26	KG142-E	KJ13F	KF26-A	KJ11B-E	DC27 #11*2
747F-514M2-25TG	E920	D440	D095	P253G-4	LP26	KG142-E	KJ13F	KF26-A	KJ11B-E	DC27 #11*2
747F-514M2-25	E920C	D440	D095	P253E-4	LP26	KG142-E	KJ13F	KF26-A	KJ11B-E	DC27 #11*2
747F-514M2-25CT	E920C	D440	D095	P253E-4	LP26	KG142-E	KJ13F	KF26-A	KJ11B-E	DC27 #11*2
747F-514M4-23	E804	D440	D674	P230-A	LP26	KG142-E	KJ13F	KF25-A	KJ11B-E	DC27 #11*2
747F-514M4-23CT	E804C	D440	D674	P230-A	LP26	KG142-E	KJ13F	KF25-A	KJ11B-E	DC27 #11*2
747F-514M5-23BK	E591B	D969	D657	P975-4	LP26	KG142-E	KJ13F	KF26-A	KJ11B-E	DC27 #11*2
747F-514M7-23	E804A	D441	D674	P230-A	LP38	KG142-E	KJ13F	KF26-A	KJ11B-E	DC27 #16*2

機 型 MODEL	針板 NEEDLE PLATE	送具 FEED DOG	送具 FEED DOG	送具 FEED DOG	押具 PRESSER FOOT	勾 針 LOOPER	針留 NEEDLE CLAMP	束 子 COLLAR	衝 程 CRANK	衝 程 CRANK	衝 程 CRANK	針 號 NEEDLE
747F-514M7-23CT	E804AC	D441	D674	H446	P230-A	LP38	KG142-E	KJ13F	KF26-A	KJ11B-E	KF26-A	DC27 #11*2
747F-514M7-24	E919A	D441	D095	H446	P253E-4	LP38	KG142-E	KJ13F	KF26-A	KJ11B-E	KF26-A	DC27 #16*2
747F-514M7-24CT	E919AC	D441	D095	H446	P253E-4	LP38	KG142-E	KJ13F	KF26-A	KJ11B-E	KF26-A	DC27 #16*2
747F-514M7-25	E920A	D441	D095	H446	P253E-4	LP38	KG142-E	KJ13F	KF26-A	KJ11B-E	KF26-A	DC27 #16*2
747F-514M7-25CT	E920AC	D441	D095	H446	P253E-4	LP38	KG142-E	KJ13F	KF26-A	KJ11B-E	KF26-A	DC27 #16*2
747F-514M7-24TG	E919A	D441	D095	H446	P254G-4	LP38	KG142-E	KJ13F	KF26-A	KJ11B-E	KF26-A	DC27 #16*2
747F-514M7-25TG	E920A	D441	D095	H446	P254G-4	LP38	KG142-E	KJ13F	KF26-A	KJ11B-E	KF26-A	DC27 #16*2
747F-514F1-24	E990	D438	D674	H442	P152D-4	LP26	KG142-E	KJ13F	KF26-A	KJ11B-E	KF26-A	DC27 #11*2
747F-514M5-23BK/VT	E591B	D675	D969	H974	P975-4	LP26	KG142-E	KJ13F	KF26-A	KJ11B-E	KF26-A	DC27 #11*2
747F-512M1-34	E832	D440	D095	H447	P253E-A	LP36	KG143-E	KJ13F	KF26-A	KJ11B-E	KF26-A	DC27 #14*2
757F-401M1/TW	E110			H101	P767-A	LP26	KG153-E		KF26-A		KF26-A	DC27 #14*2
757F-401M2-50TA	E005	D005	D006	H005	P005-A		TA155-E		KF26-A		KF26-A	DC27 #14*2
757F-401M2-50TA/EC	E005C	D005	D006	H005	P005-A		TA155-E		KF26-A		KF26-A	DC27 #14*2
757F-516H2-56	E868	D490	D502	H501	P502-A	LP38	KG155-E	KJ13F	KF26-A	KJ11B-E	KF26-A	DC27 #18*2
757F-516H2-56CT	E868C	D490	D502	H501	P502-A	LP38	KG155-E	KJ13F	KF26-A	KJ11B-E	KF26-A	DC27 #18*2
757F-516H4-35GA	E982	D008	D502	H957	P508-A	LP26	KG153-E	KJ10F	KF25-A	KJ09B-E	KF25-A	DC27 #14*2
757F-516H4-35GA/EC	E982C	D008	D502	H957	P508-A	LP26	KG153-E	KJ10F	KF25-A	KJ09B-E	KF25-A	DC27 #14*2
757F-516H4-35GA/P	E982	D008	D502	H957	P508P-A	LP26	KG153-E	KJ10F	KF25-A	KJ09B-E	KF25-A	DC27 #14*2
757F-516H4-35GA/P/EC	E982C	D008	D502	H957	P508P-A	LP26	KG153-E	KJ10F	KF25-A	KJ09B-E	KF25-A	DC27 #14*2
757F-516H4-55GA	E986	D956	D502	H957	P509-A	LP26	KG155-E	KJ10F	KF25-A	KJ09B-E	KF25-A	DC27 #14*2
757F-516H4-55GA/EC	E986C	D956	D502	H957	P509-A	LP26	KG155-E	KJ10F	KF25-A	KJ09B-E	KF25-A	DC27 #14*2
757F-516H4-55GA/P	E986	D956	D502	H957	P509P-A	LP26	KG155-E	KJ10F	KF25-A	KJ09B-E	KF25-A	DC27 #14*2
757F-516H4-55GA/P/EC	E986C	D956	D502	H957	P509P-A	LP26	KG155-E	KJ10F	KF25-A	KJ09B-E	KF25-A	DC27 #14*2

## 規格件表 CONVERSION CHART

# 型別件對照表 MODEL COMPARE LIST

機 型 MODEL										
	針板 NEEDLE PLATE	送具 FEED DOG	送具 FEED DOG	押具 PRESSER FOOT	勾 針 LOOPER	針留 NEEDLE CLAMP	束 子 COLLER	衝 程 CRANK	衝 程 CRANK	針 號 NEEDLE
757F-516L1-24	E834	D487	D060	P500-A	LP26	KG152-E	KJ10F	KF25-A	KJ09B-E	DC27 #14*2
757F-516L1-24CT	E834C	D487	D060	P500-A	LP26	KG152-E	KJ10F	KF25-A	KJ09B-E	DC27 #14*2
757F-516L1-35	E839	D487	D060	P504-A	LP26	KG153-E	KJ10F	KF25-A	KJ09B-E	DC27 #14*2
757F-516L1-35CT	E839C	D487	D060	P504-A	LP26	KG153-E	KJ10F	KF25-A	KJ09B-E	DC27 #14*2
757F-516M2-35	E982	D489	D502	P504-A	LP26	KG153-E	KJ10F	KF25-A	KJ11B-E	DC27 #14*2
757F-516M2-35CT	E982C	D489	D502	P504-A	LP26	KG153-E	KJ10F	KF25-A	KJ11B-E	DC27 #14*2
757F-516M2-35PS	E982S	D489	D502	P504S-A	LP26	KG153-E	KJ10F	KF25-A	KJ11B-E	DC27 #14*2
757F-516M2-35PS/EC	E982SC	D489	D502	P504S-A	LP26	KG153-E	KJ10F	KF25-A	KJ11B-E	DC27 #14*2
757F-516M2-55	E986	D489	D502	P502-A	LP26	KG155-E	KJ10F	KF25-A	KJ11B-E	DC27 #14*2
757F-516M2-55CT	E986C	D489	D502	P502-A	LP26	KG155-E	KJ10F	KF25-A	KJ11B-E	DC27 #14*2
757F-516M2-55PS	E986S	D489	D502	P502S-A	LP26	KG155-E	KJ10F	KF25-A	KJ11B-E	DC27 #14*2
757F-516M2-55PS/EC	E986SC	D489	D502	P502S-A	LP26	KG155-E	KJ10F	KF25-A	KJ11B-E	DC27 #14*2
757F-516X2-56	E870	D490	D502	P960-A	LP38	KG155-E	KJ13F	KF26-A	KJ11B-E	DC27 #18*2
757F-516X2-56CT	E870C	D490	D502	P960-A	LP38	KG155-E	KJ13F	KF26-A	KJ11B-E	DC27 #18*2
757F-516X3-56	E870	D490	D502	P960-A	LP38	KG155A-E	KJ13F	KF26-A	KJ11B-E	TVX64#21*2
757F-516X3-56CT	E870C	D490	D502	P960-A	LP38	KG155A-E	KJ13F	KF26-A	KJ11B-E	TVX64#21*2
757F-516M2-55/EC	E986C	D489	D502	P502-A	LP26	KG155-E	KJ13F	KF25-A	KJ11B-E	DC27 #14*2
757F-401M1/TW/CT	E110C			P767-A	LP26	KG153-E	KJ13F	KF25-A	KJ09B-E	DC27 #14*2
767F-516M2-324	E989	D971	D502	P233-A	LP26	KG333-E	KJ13F	KF26-A	KJ11B-E	DC27 #11*3
767F-516M2-324/CT	E989C	D971	D502	P233-A	LP26	KG333-E	KJ13F	KF26-A	KJ11B-E	DC27 #11*3
767F-516M2-524	E988	D972	D502	P255-A	LP26	KG355-E	KJ13F	KF26-A	KJ11B-E	DC27 #11*3
767F-516M2-524CT	E988C	D972	D502	P255-A	LP26	KG355-E	KJ13F	KF26-A	KJ11B-E	DC27 #11*3





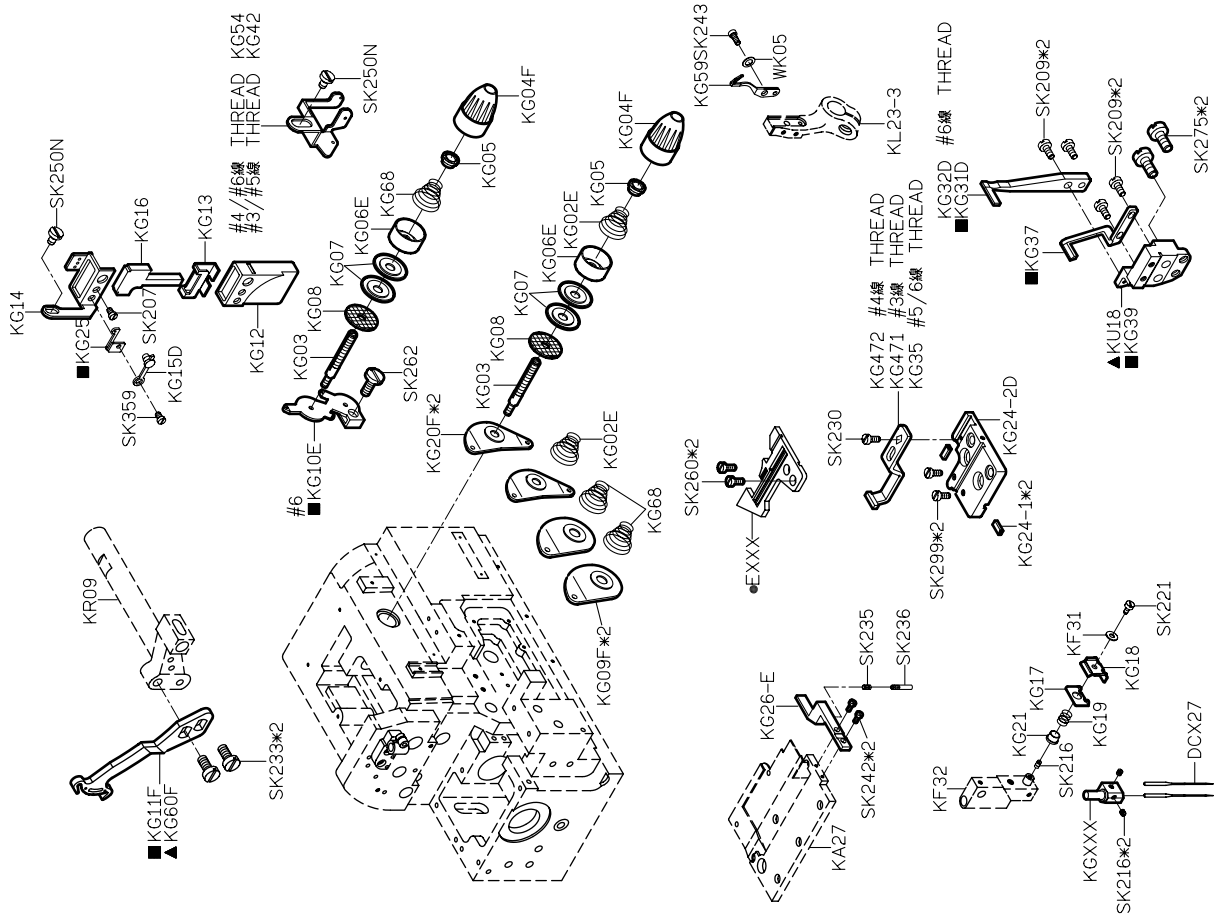

PARTS LIST FOR KG GROUP

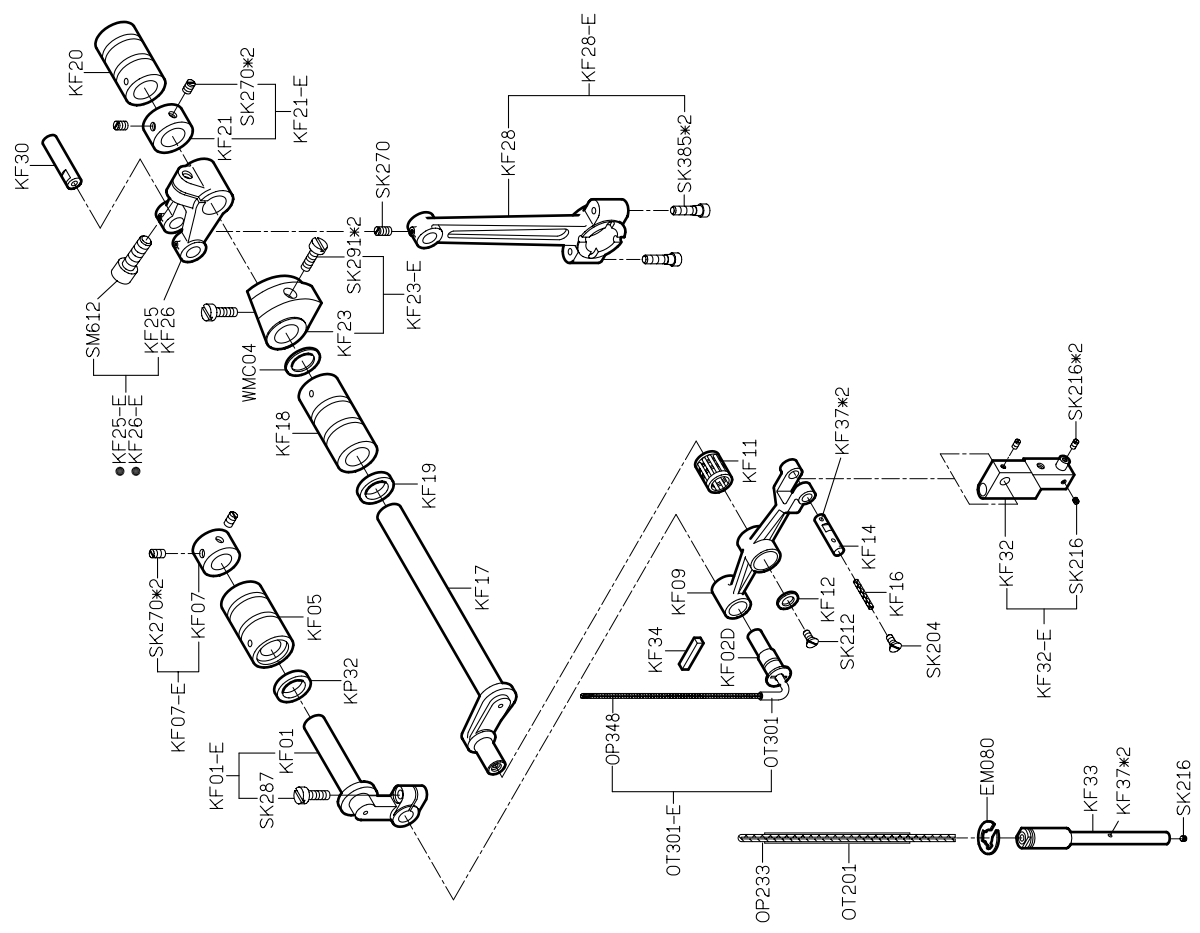

PARTS LIST FOR KF GROUP



PARTS LIST FOR KL GROUP

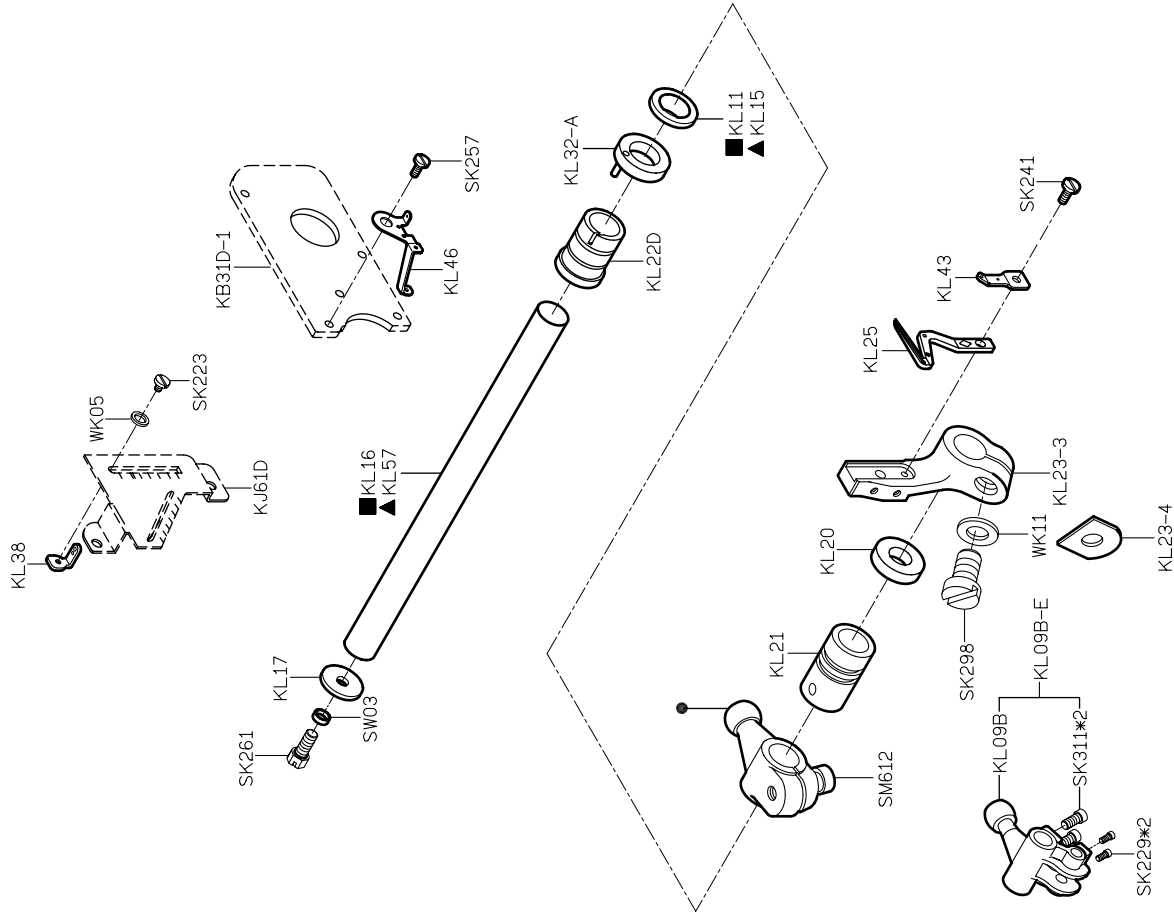

PARTS LIST FOR KJ GROUP

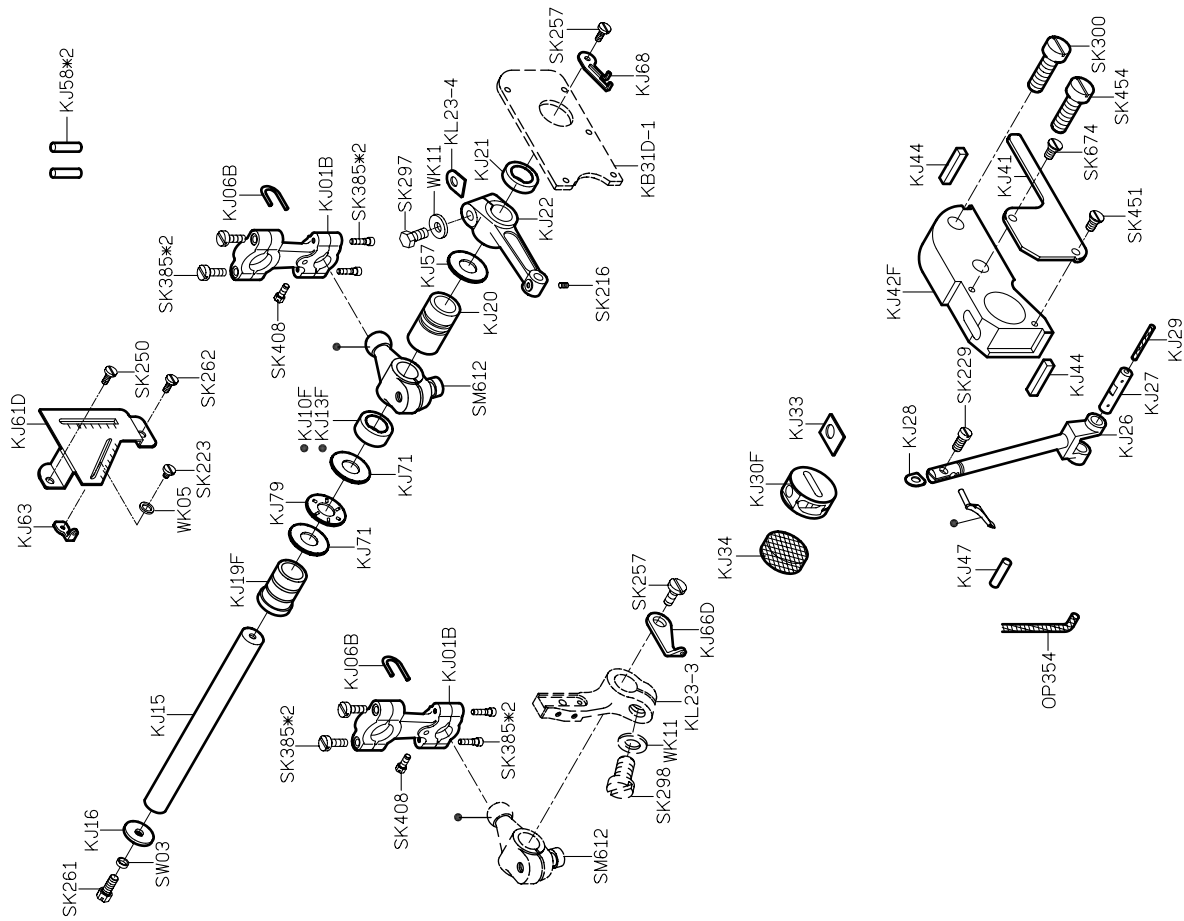

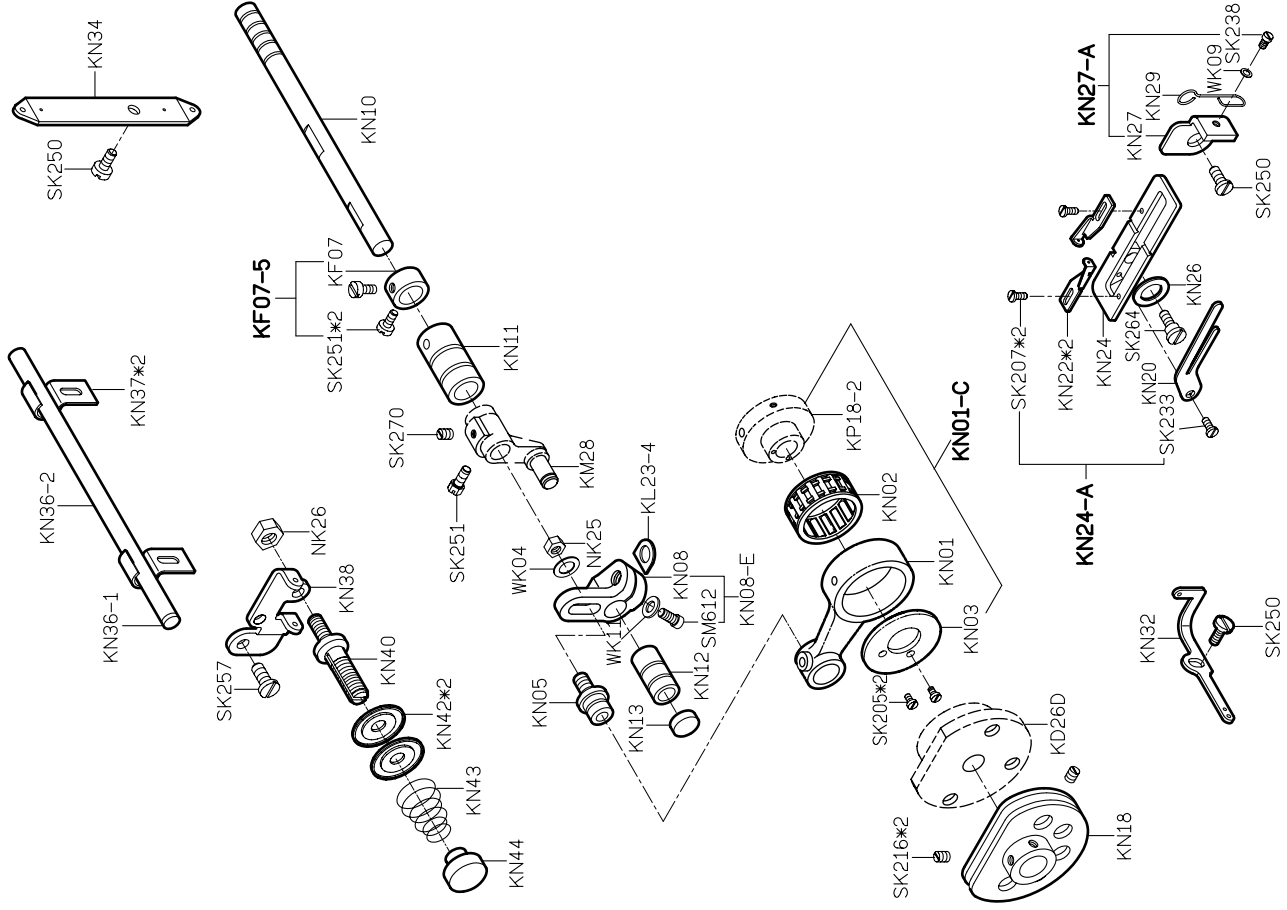

PARTS LIST FOR KN GROUP

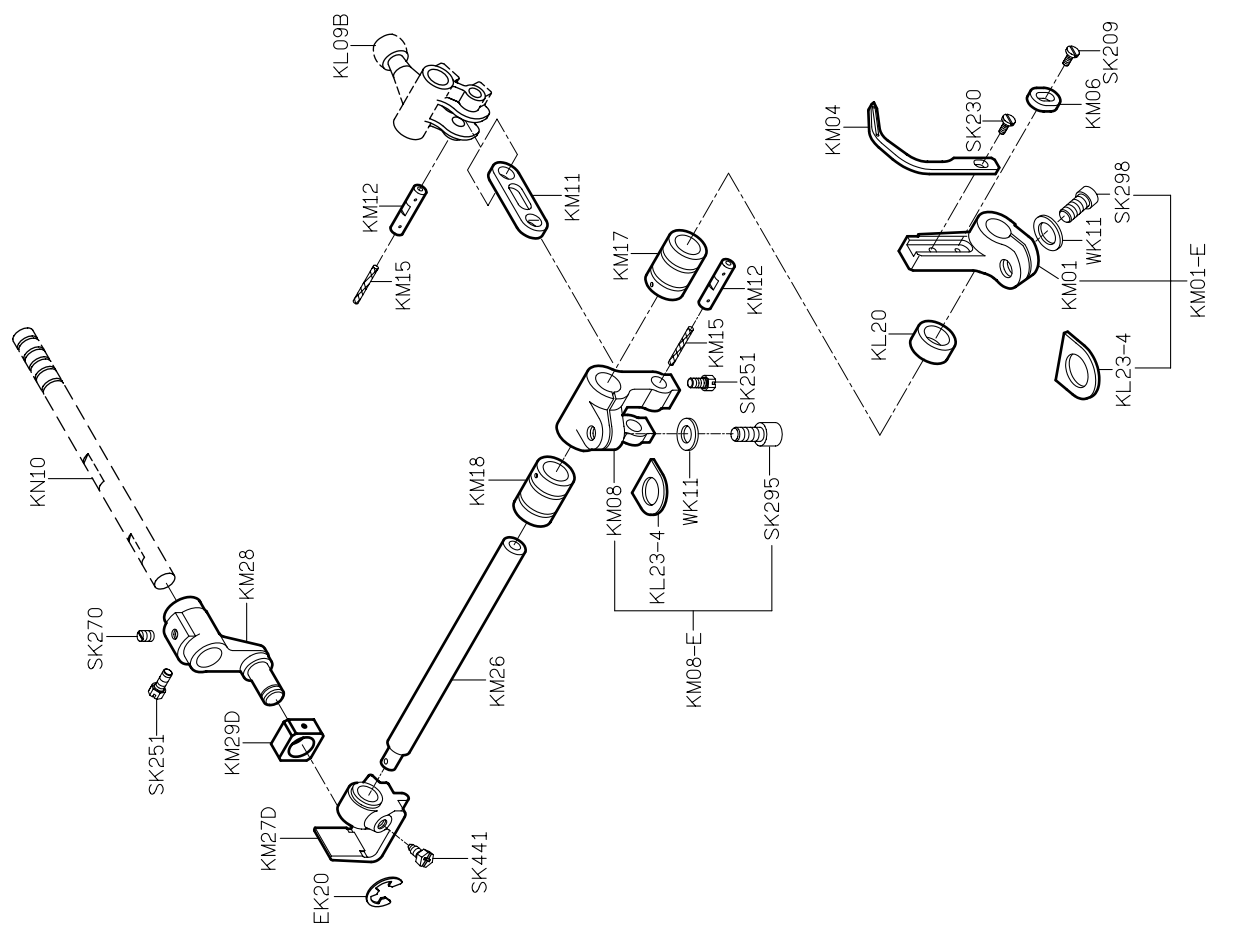

PARTS LIST FOR KM GROUP

# PARTS LIST FOR KP GROUP

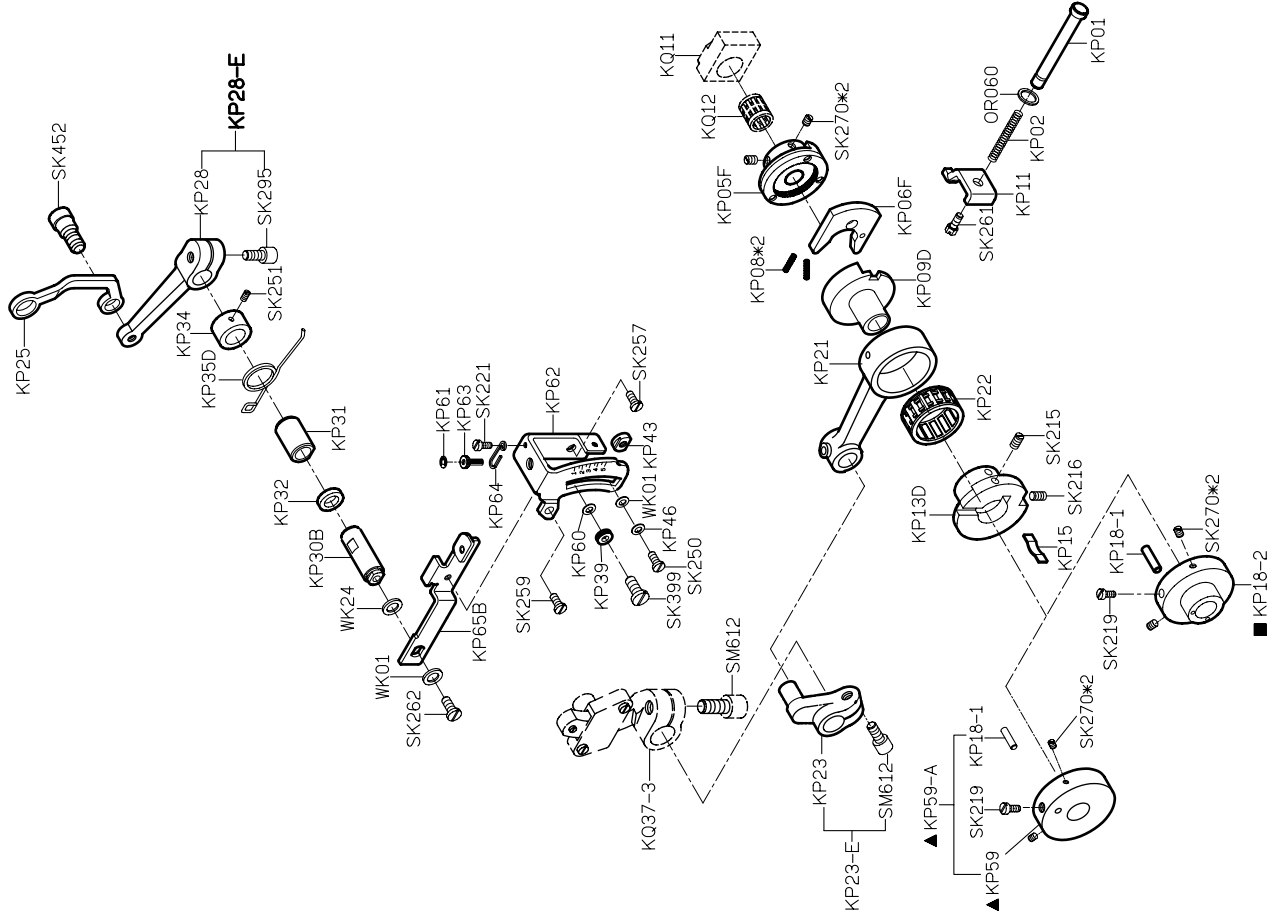

# PARTS LIST FOR KQ GROUP

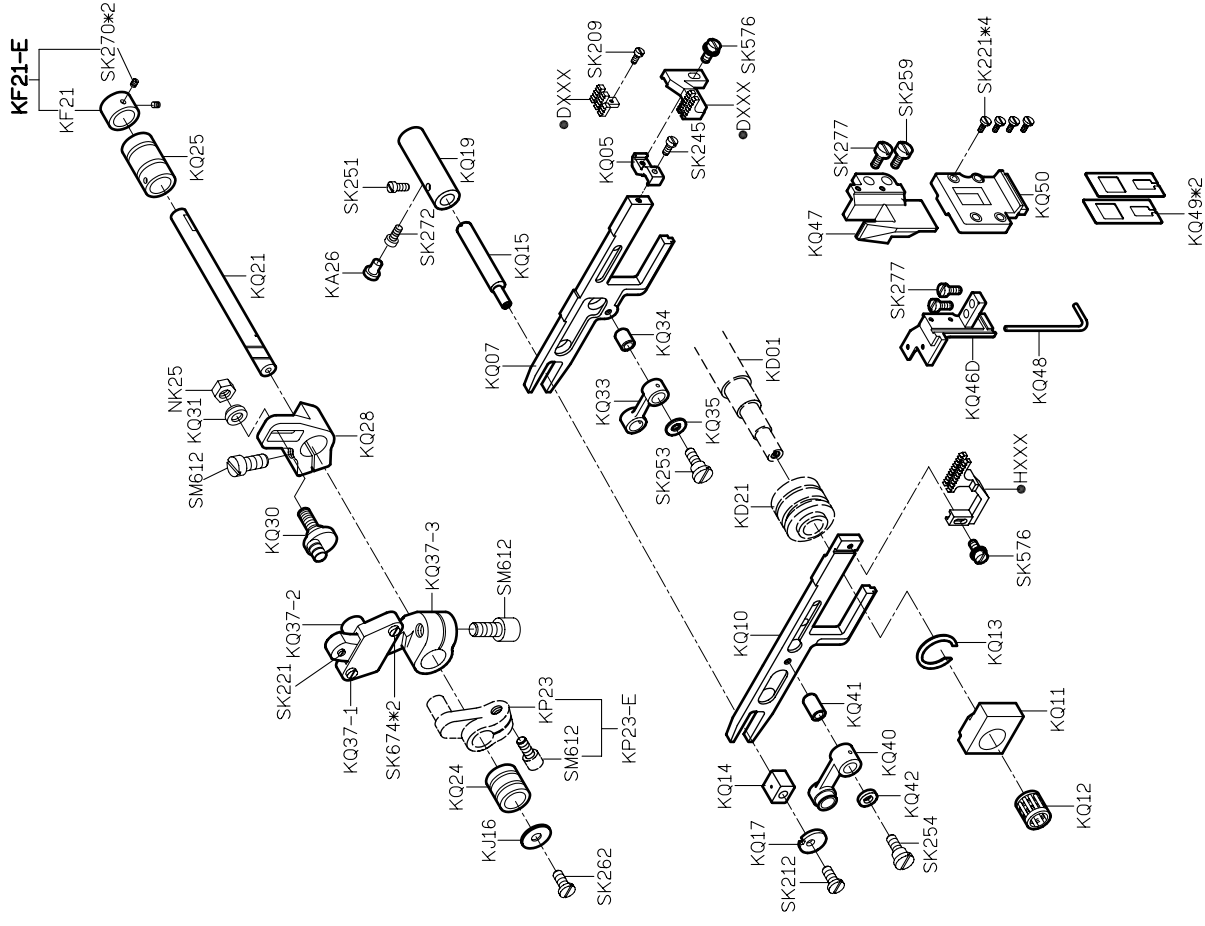

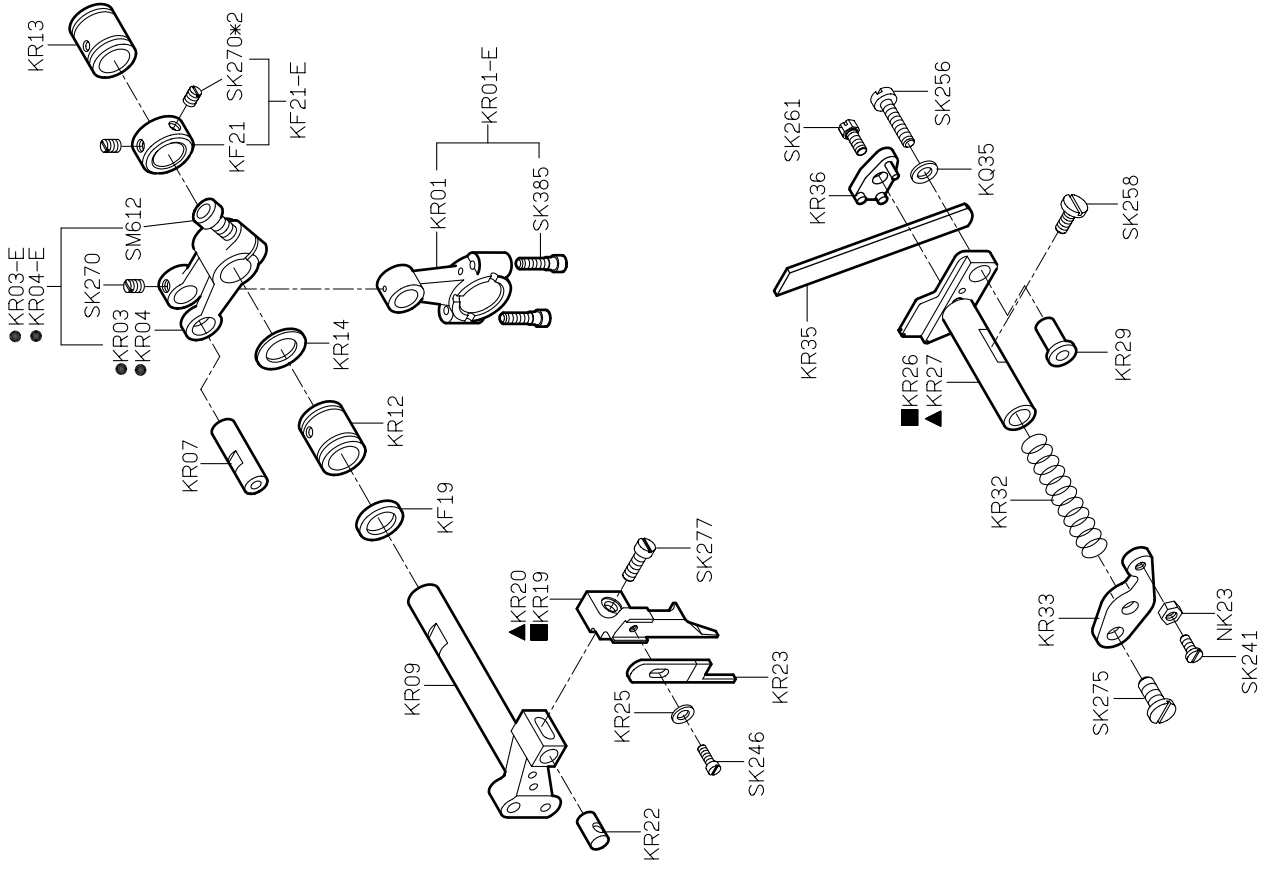

PARTS LIST FOR KR GROUP

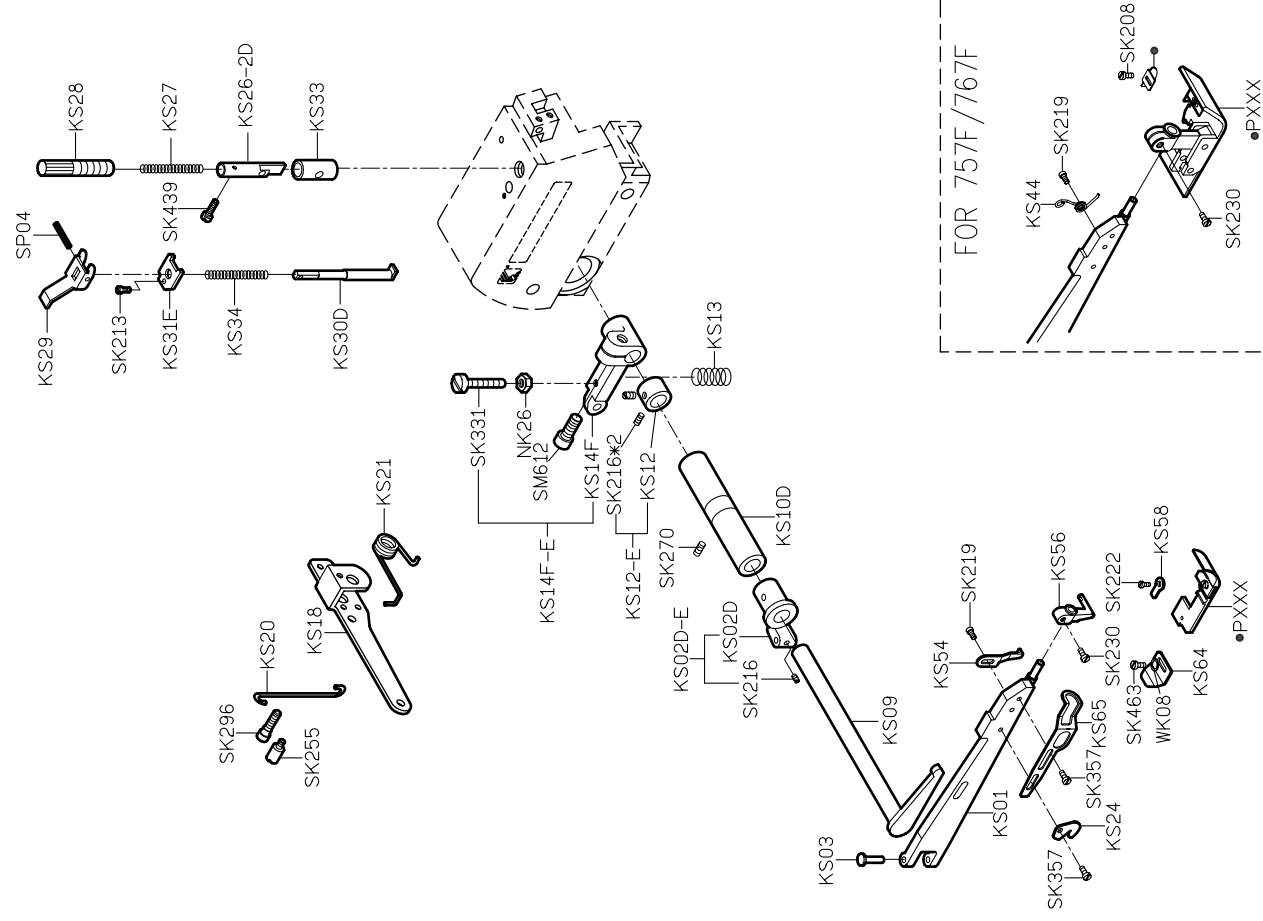

PARTS LIST FOR KS GROUP

# PARTS LIST FOR KT GROUP

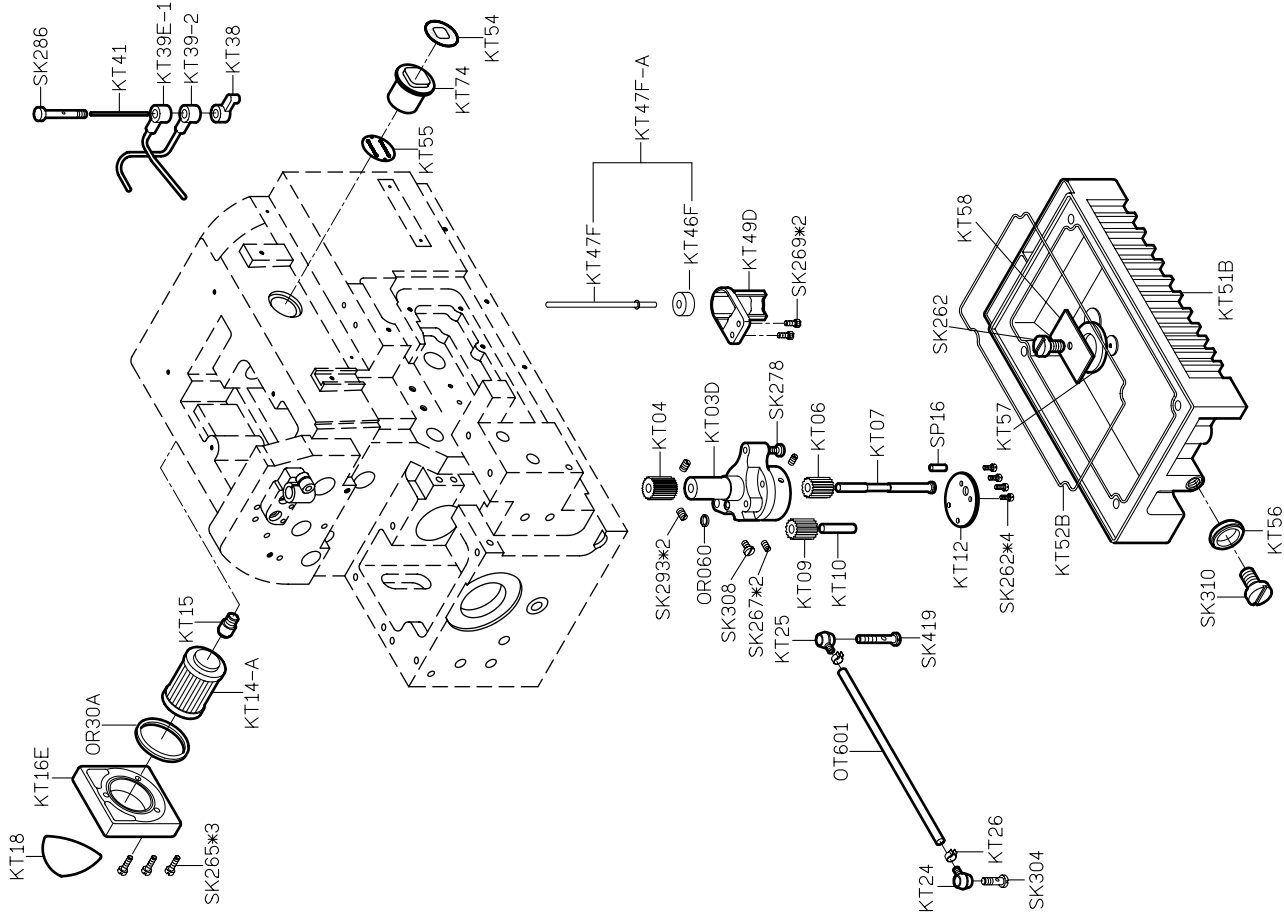

# PARTS LIST FOR KU GROUP

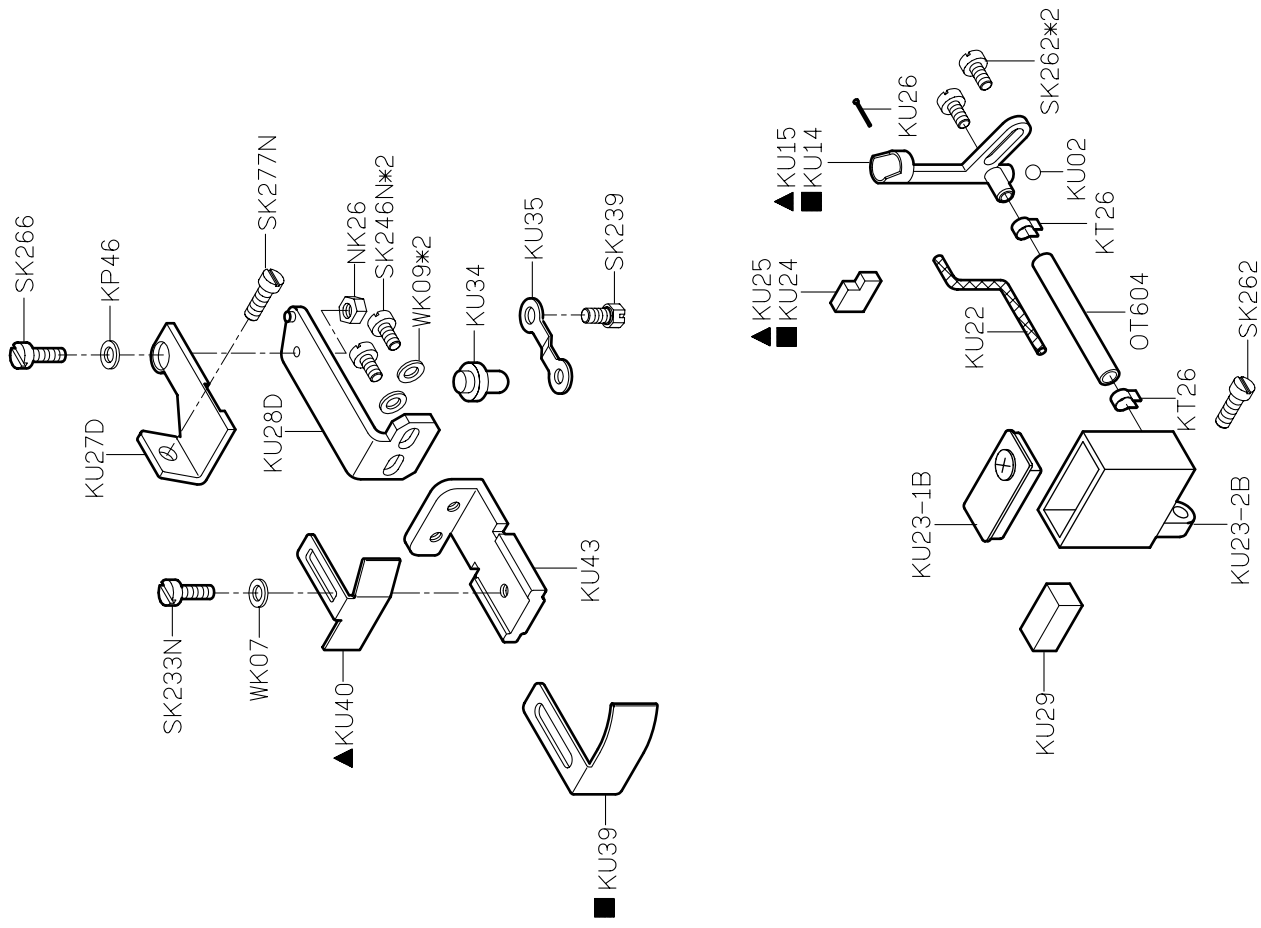

KW40E-3

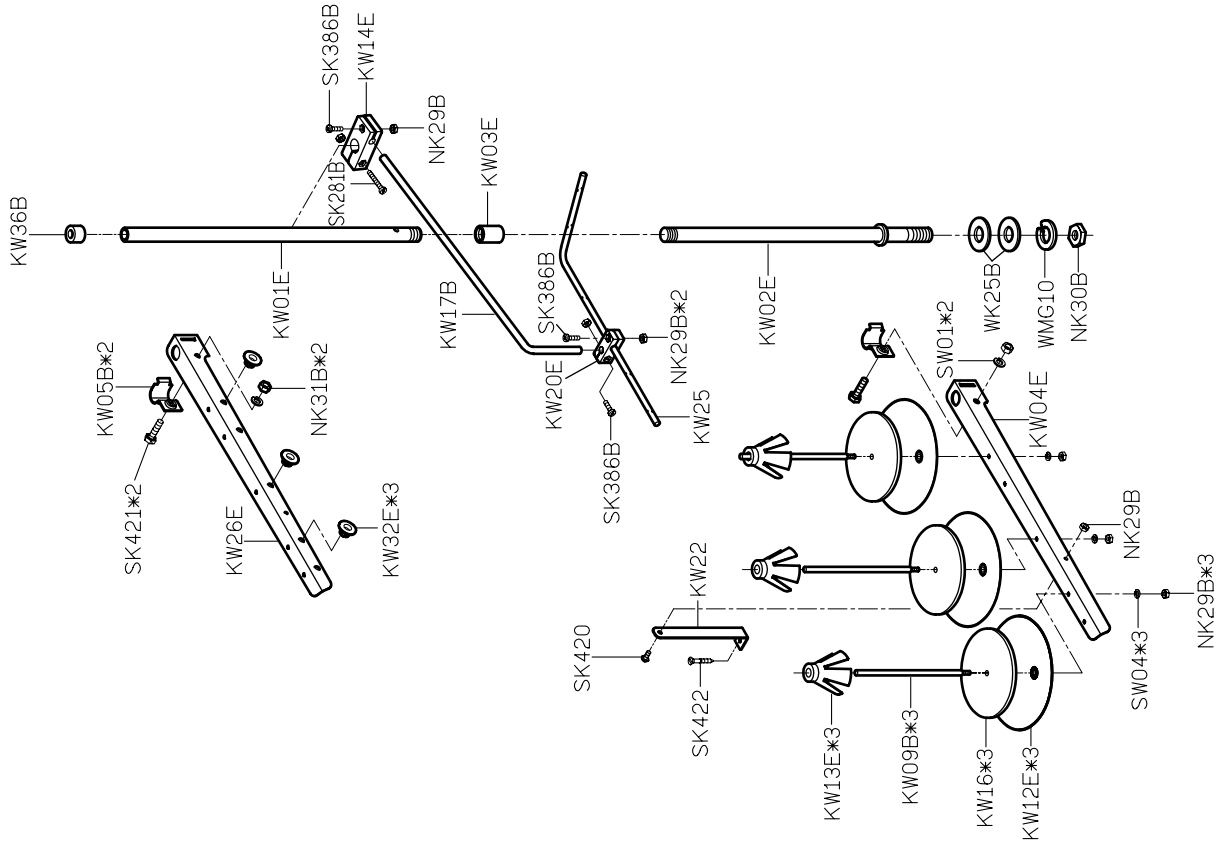

KW40E-4

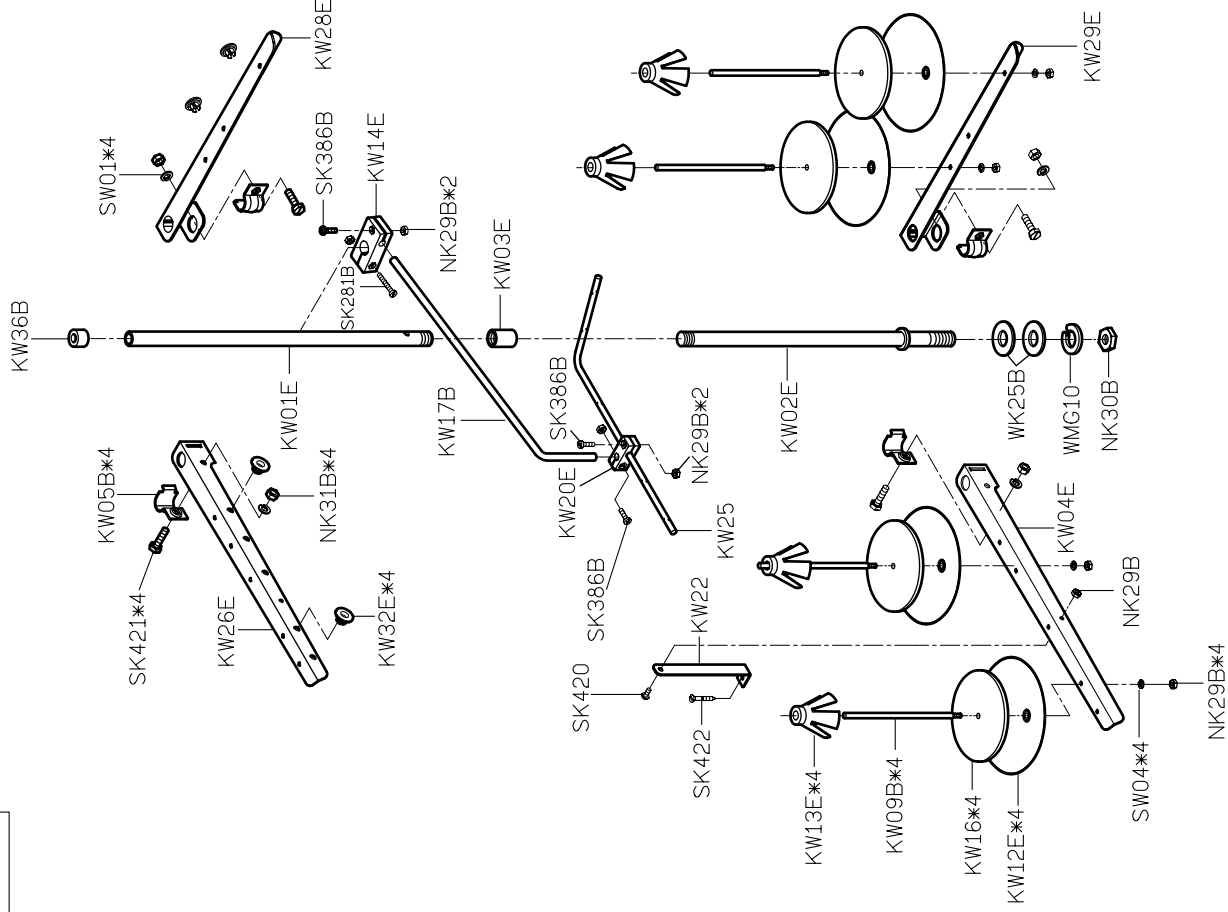

PARTS LIST FOR KW GROUP

PARTS LIST FOR KW GROUP

KW40E-5

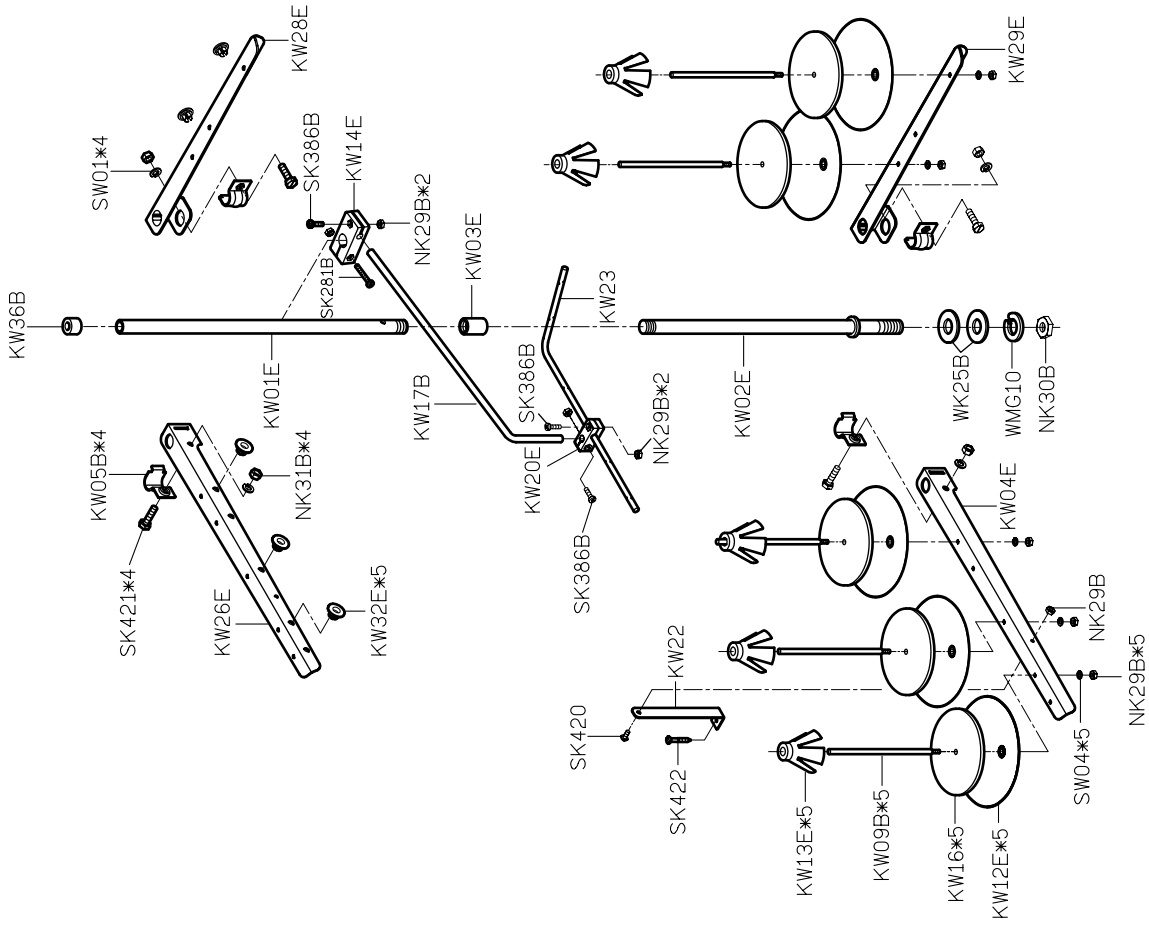

KW40E-6

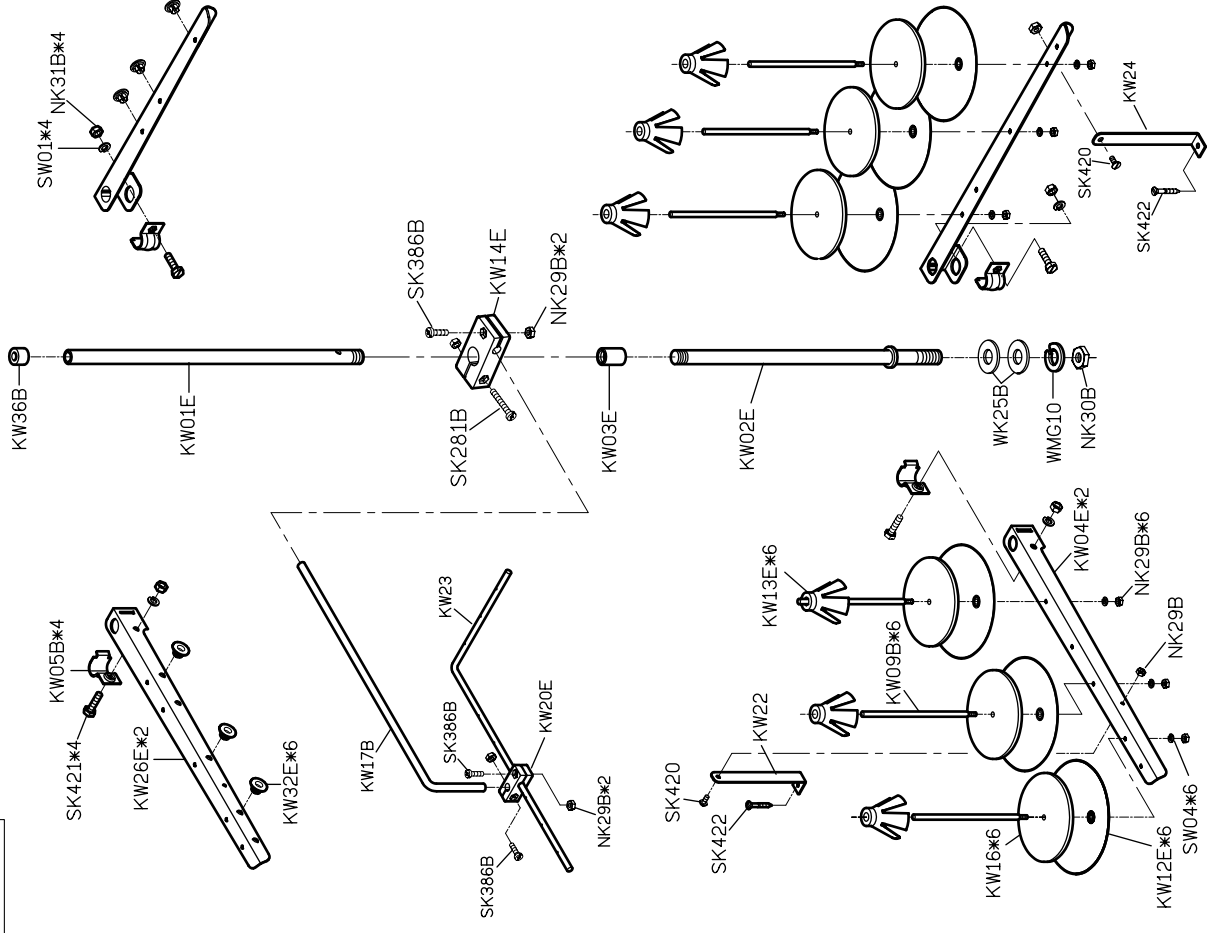

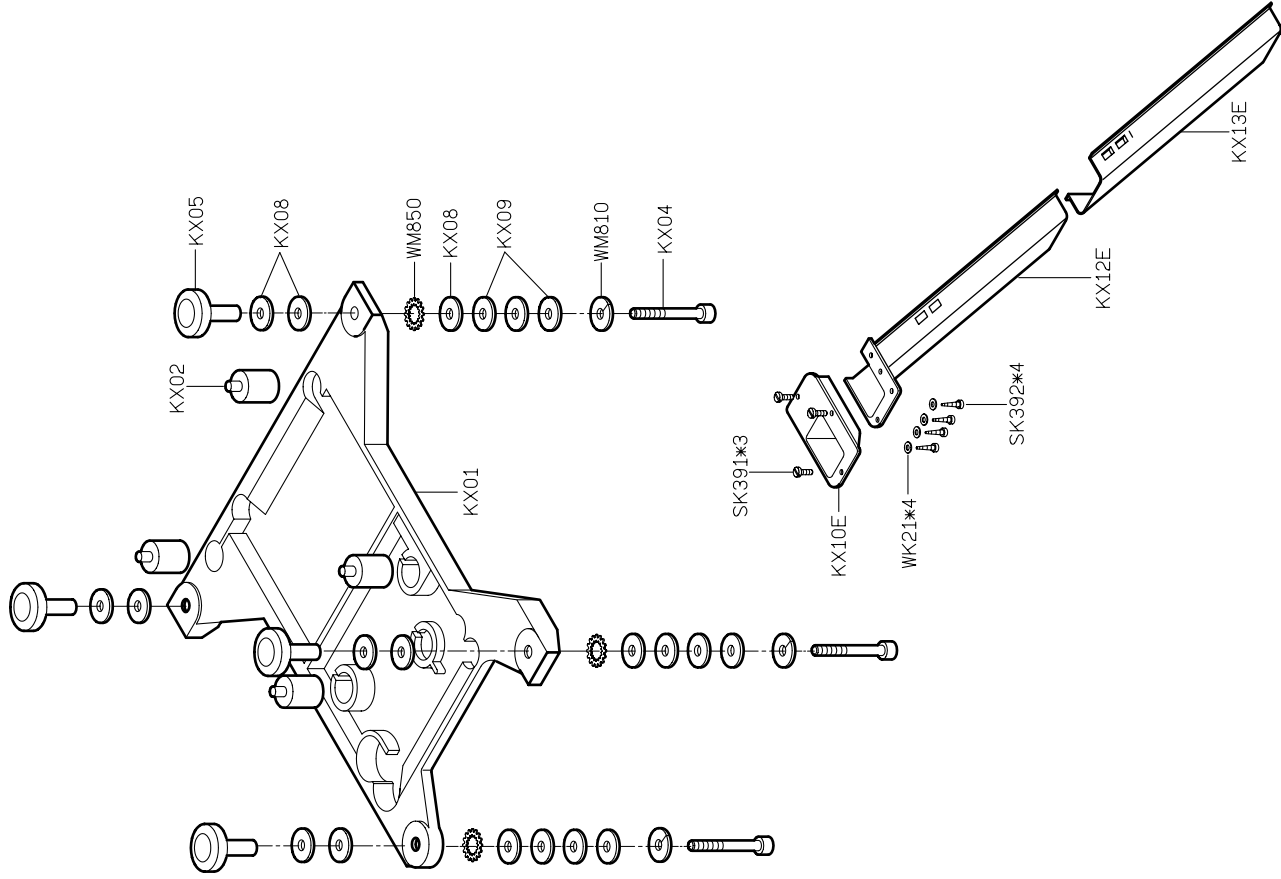

## PARTS LIST FOR KX GROUP

KY01  
防塵罩

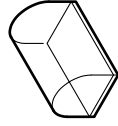

KY07  
開口板手

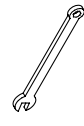

KY12  
六角板手



KY19  
穿線器



KY02-A  
油罐

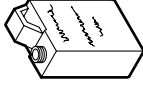

KY08  
開口板手



KY14  
內六角螺絲起子



KY20D  
腳踏板



KT14-A  
濾油器



SK216\*2  
螺絲



KY03  
油壺

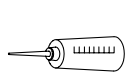

KY09  
開口板手

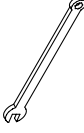

KY16  
一字起子

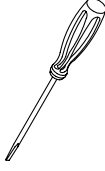

KY21-A/MY21  
鉤子/鍊條



針\*4



KY04  
漏斗



KY10  
六角板手



KY17  
一字起子

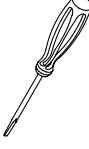

KY26F  
工具袋



KZ08F  
零件圖

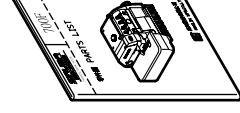

KY05  
油壺



KY11  
六角板手



KY18  
鑷子



KR35  
下刀片

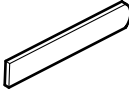

KZ08F-2  
使用說明書

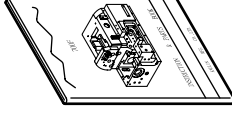



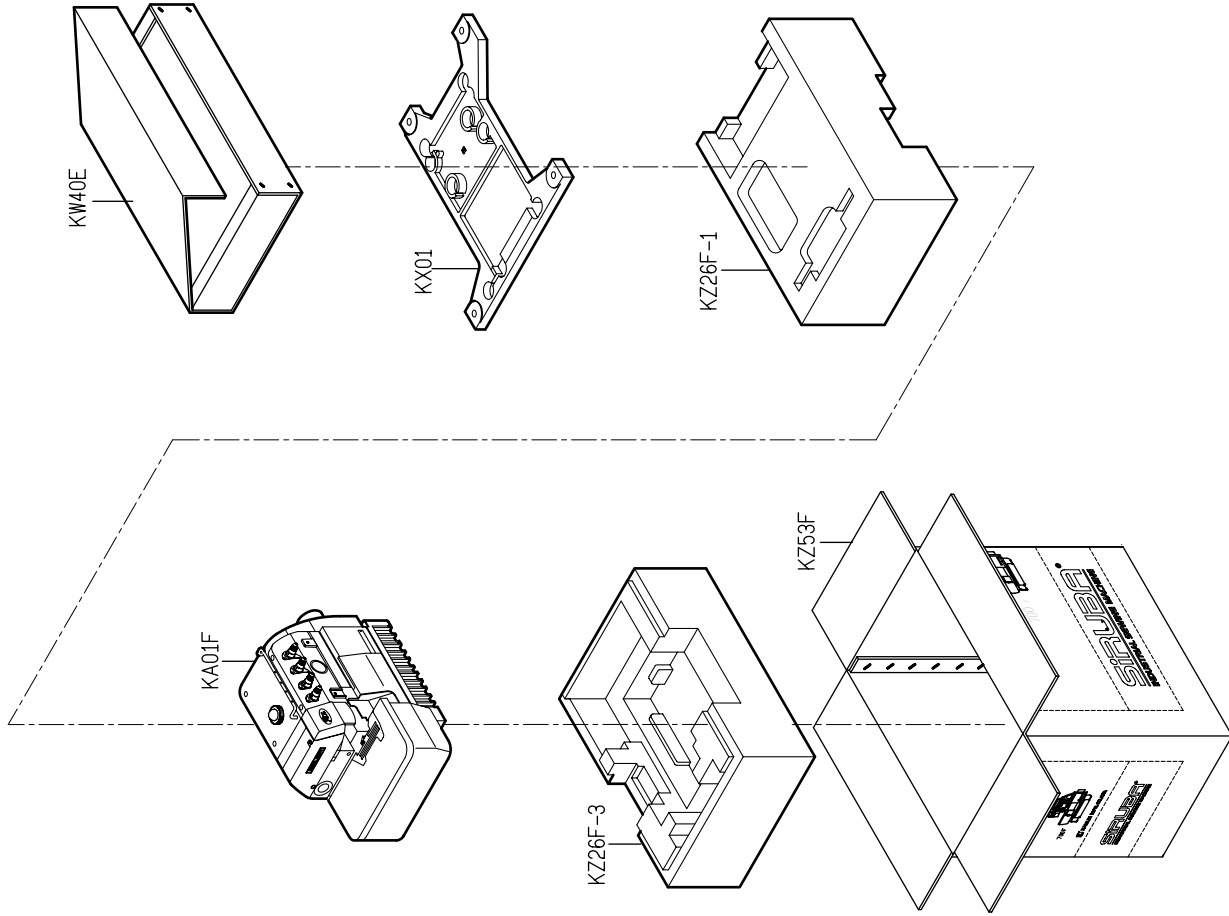



# 700F

高林股份有限公司 KAULIN MFG. CO., LTD.